

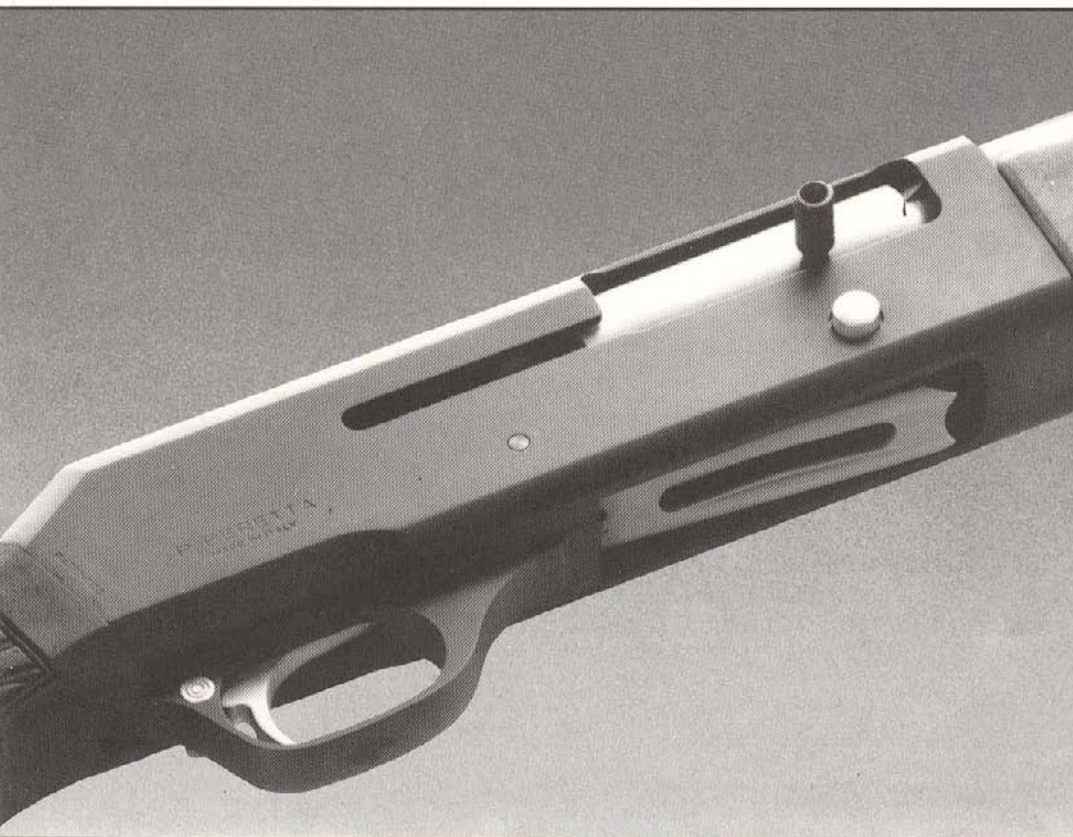

Beretta
A TRADITION OF EXCELLENCE SINCE 1526

1200 F



Istruzioni per l'uso
Instructions for operation
Mode d'emploi

Illustrations on pages 5, 34, 35

Caution: read this manual carefully before handling and loading the gun.

The commandments of gun safety

- 1) Treat every gun with respect and caution.
- 2) Keep your eyes on the muzzle. Keep the safety on until ready to shoot.
- 3) Unload guns when not in use; keep the actions open.
- 4) Be sure the barrel is clear of obstructions.
- 5) Be certain of the target at which you are going to fire. Know how to recognize the game you are hunting.
- 6) Never shoot at a flat surface or water.
- 7) Never climb a tree or fence or jump a ditch with a loaded gun. Don't take a gun by the barrel.
- 8) Never point a gun at anything you don't want to shoot. Avoid all horseplay while handling a gun.
- 9) Store guns and ammunition separately, beyond the reach of children. Guns should always be unloaded.
- 10) Avoid alcoholic beverages before or during shooting.

Shooting glasses and **earplugs**: shooting glasses are a **must**; chances of gas, gunpowder and dirt particle blow-back are remote but to exist. Earplugs reduce the chance of temporary or permanent loss of hearing when shooting.

Warning

As the interchangeable barrel of the automatic has a different serial number to that stamped on the receiver, it may be necessary, when referring to the gun, to specify also the serial number of the barrel/s.

CONTENTS

| | Page |
|---------------------------------------|-----------|
| DESCRIPTION AND SPECIFICATIONS | 16 |
| a. Main parts | 17 |
| b. Assembly | 17 |
| c. Functioning and operation | 19 |
| d. Disassembly | 20 |
| e. Cleaning and lubricating | 21 |
| f. Magazine capacity | 22 |
| g. Reassembly | 23 |

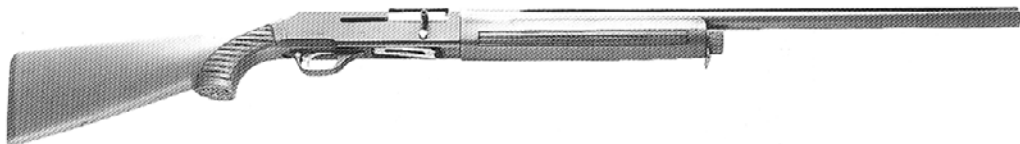

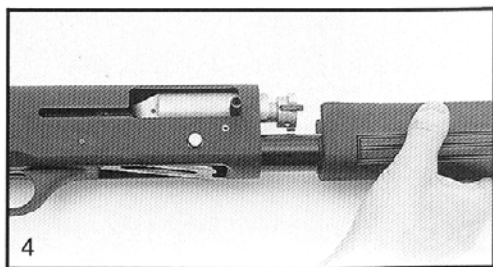
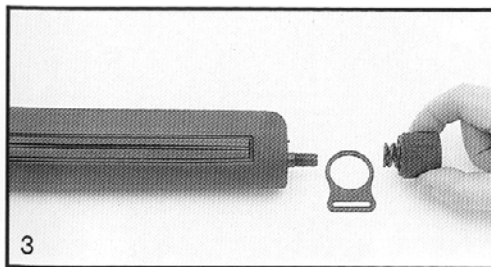
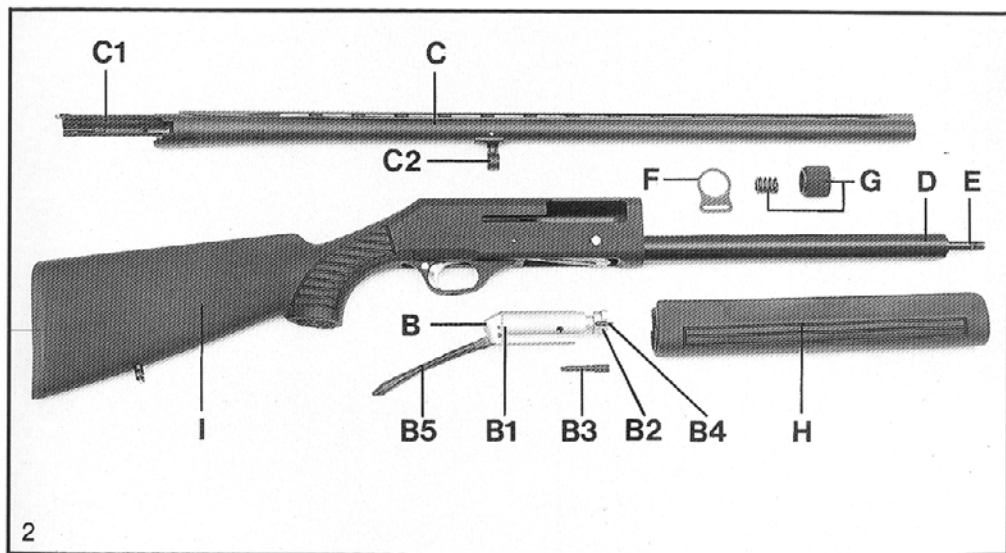
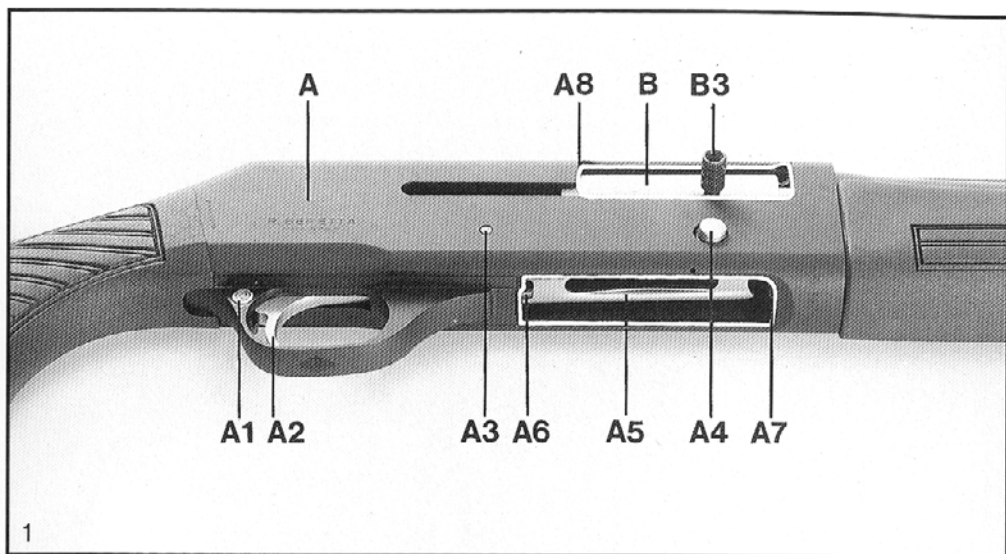

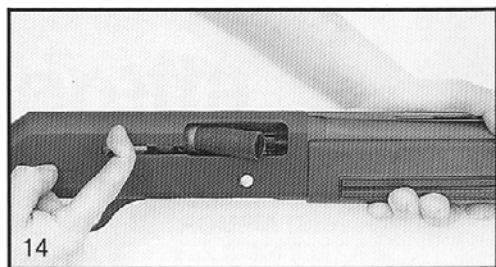
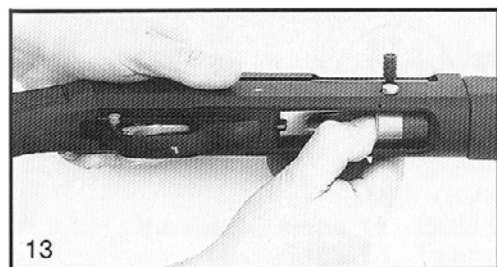
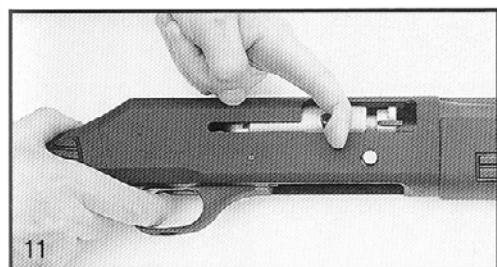
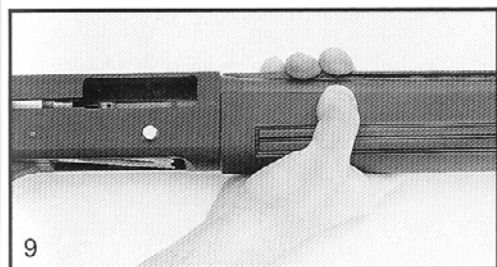
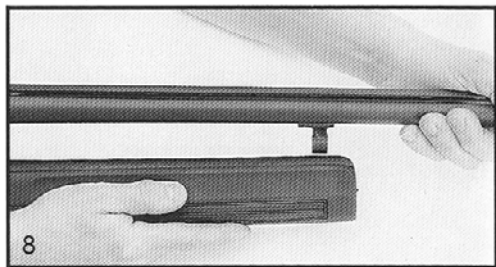
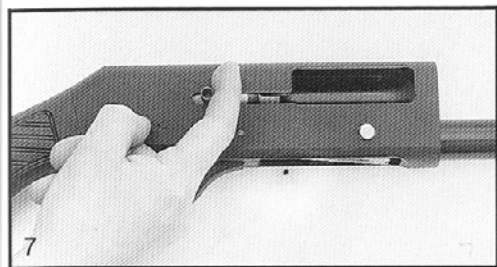
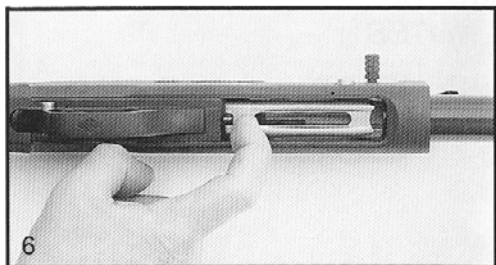
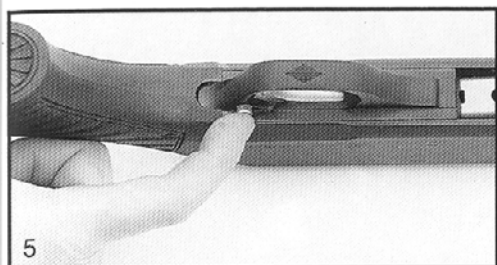

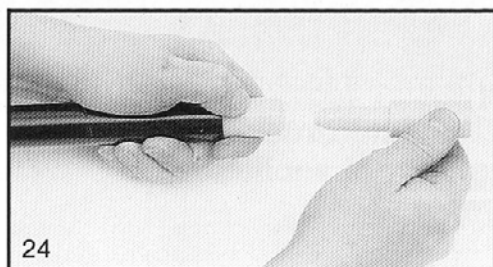
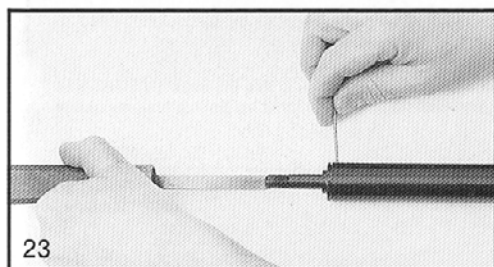
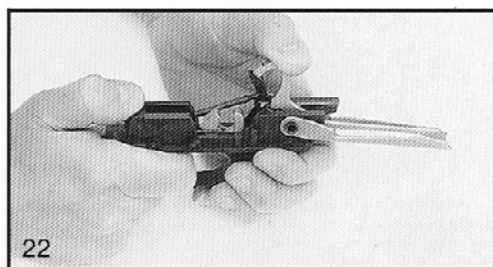
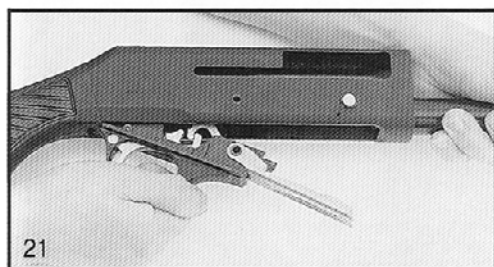
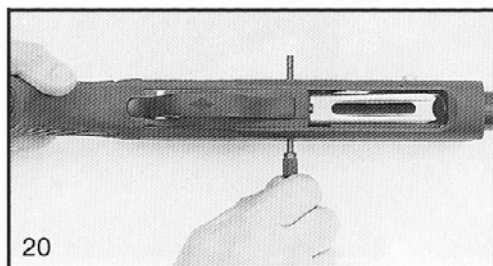
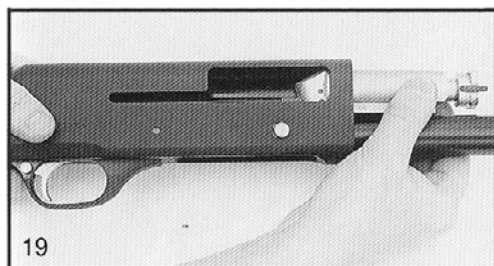
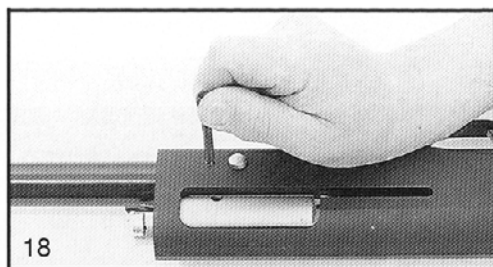
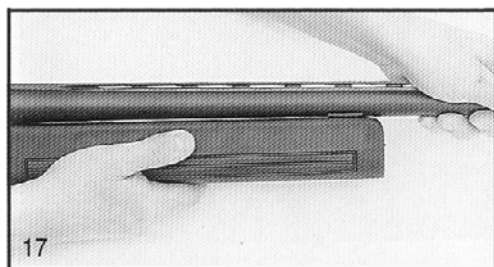
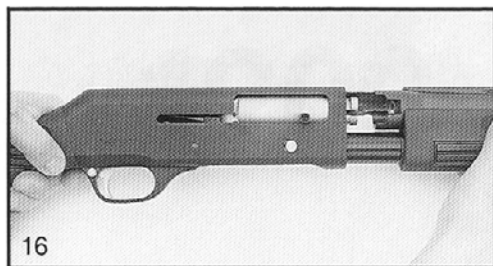
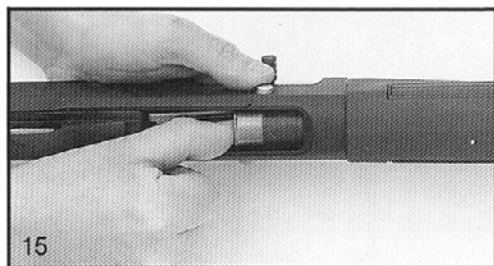

DESCRIPTION

The Beretta 1200 F is really an "all-field shotgun", with simple mechanisms, essential finish, rugged and reliable.

The **stock and forend** are made of a special strengthened technopolymer. The impact strength, abrasion resistance, weatherability, strain strength and endurance of this material fully meet the severe ordnance specifications required by military firearms.

The **operation system**, both simple and practical, uses by inertia the kinetic energy of the recoil. The breech bolt assembly consists of a limited number of components, among which, the rotating head, ensures a perfect locking on the barrel extension.

This system, in conjunction with the fixed barrel, gives a remarkable shooting stability.

The **trigger plate assembly** is also very simple: a single pin is sufficient to fix it to the receiver.

The **feeding assembly** is designed in order to ensure a correct feeding, even when using the most powerful shotshells. No special tools are needed for disassembling.

The matted grey chromed trigger, safety, feeding lever and bolt release button stand out against the matted black finish of the entire shotgun.

SPECIFICATIONS

| | |
|--------------------------|---------------------------------------------------------|
| Gauge | 12 |
| Cartridge chamber | 70 mm |
| Barrel length and Chokes | 71 cm - 0/00/000 |
| Barrel | hard-chromed bore |
| Rib | plain ventilated rib |
| Front sight | metal bead |
| Operation | inertia operated |
| Locking system | rotating bolt |
| Safety | cross bolt |
| Magazine | plugged to 2 rounds (3 rounds including one in chamber) |
| Stock, Forend | made of special strengthened technopolymer |
| Length of stock | 365 mm |
| Weight (approx.) | 3,100÷3,250 Kg. |
| Finish | matted black and matted grey |

| | | |
|--------------------|----|-----|
| 0 | F | 1/1 |
| 00 | IM | 3/4 |
| 000 | M | 1/2 |
| 0000 | IC | 1/4 |
| C0000 | C | 0/0 |
| S (Skeet) | S | SK |
| SB (Skeet Beretta) | | |

a. Main parts

The Beretta automatic shotgun Mod. 1200 F is factory packed in two parts: Stocked action and barrel.

Before assembling the barrel on to the stocked action study **ill. 1 and 2** which show the principal parts.

Nomenclature:

A RECEIVER

- | | |
|---------------------------------------|------------------------------------|
| A1 Safety button | A5 Carrier |
| A2 Trigger | A6 Carrier stop push button |
| A3 Trigger plate retaining pin | A7 Loading gate |
| A4 Breech bolt release button | A8 Ejection port |

B BREECH BOLT ASSEMBLY GROUP (main parts)

- | | |
|--------------------------|--------------------------|
| B1 Slide | B4 Extractor |
| B2 Locking head | B5 Connecting rod |
| B3 Cocking handle | |

C BARREL

- | | |
|-----------------------|-----------------|
| C1 Barrel tang | C2 Tenon |
|-----------------------|-----------------|

D MAGAZINE TUBE

E MAGAZINE TUBE CAP WITH SHAFT

F SWIVEL (removable)

G FORE-END CAP (with spring)

H FORE-END

I STOCK

b. Assembly

Assemble the shotgun as follows:

- b.1** Check the barrel. Bore and cartridge chamber must be clean and free from obstructions.
- b.2** Check that magazine tube and receiver are empty by looking through the loading gate.
- b.3** Keeping the front end elevated, unscrew (counter-clockwise) the fore-end cap and, should the spring not come away with the cap, remove the spring. Remove the swivel, when mounted, and pull the fore-end off the magazine tube (**ill. 3 and 4**).

- b.4** To engage the safety push the safety button from left to right. The red spot should not be visible. When the red spot is visible it indicates that the firearm is in “FIRE” position (ill. 5).
Please Note: The safety can be engaged with the hammer either fully-cocked or fully-lowered. This permits safe action manipulation.
- b.5.** Press the carrier stop push button to lower the carrier, ready to receive the cartridge from the magazine tube (when the hammer is fully-lowered the carrier is already in the required position) (ill. 6).
- b.6** Keeping the front end elevated, with the right hand operate the cocking handle to bring the breech bolt in “open” position (ill. 7).
Please note: If the breech bolt is crawled, move it forward slightly to obtain the repositioning of the connecting rod in the recoil spring guide housing and repeat step **b.6**.
Note: When the safety is on and the hammer is fully-lowered, the breech bolt has to be retracted with some force as it has to overcome the hammer spring force.
- b.7** Hold the barrel just above the tenon: rest the barrel front section in the fore-end channel and slide the fore-end downwards until the flange stops against the tenon (ill. 8).
- b.8** Mount the barrel fore-end assembly on the magazine tube and slide the barrel tang home into the receiver. Ensure that the fore-end rests firmly against the receiver. (ill. 9).
(To facilitate this operation it might be necessary to press the fore-end to the barrel before sliding the half circular protruding lip home in the receiver).
- b.9** Slide the swivel (when supplied) and the spring on the magazine tube cap shaft, which protrudes from the fore-end flange, and screw the cap home ensuring that the swivel ring (when supplied) rests around the base of the cap.
- b.10** Close the breech bolt by depressing the breech bolt release button. Keep fingers away from the ejection port while doing so. The compressed recoil spring will close the breech and rotate the bolt head in the barrel bore, locking into “closed” position (ill. 10).
Please note: The locking of the breech bolt places the bolt carrier in top position, locked by the carrier stop push button.
- b.11** Retract the breech bolt enough to allow a visual check of the cartridge chamber, which should be empty. Be careful where you point the firearm, even though it might not be loaded. Disengage the safety and depress the trigger to lower the hammer (ill. 11).
Please note: With the hammer fully lowered the carrier automatically changes to its lower, shell receiving position, activating the breech “Retained” device.

- d.4 Hold with the right hand the fore-end barrel assembly and detach it from the stocked action by sliding it forward (ill. 16).
- d.5 With the left hand hold the barrel and with the right hand slide fore-end towards the barrel muzzle for about two centimeters so as to detach it from the barrel (ill. 17).

BREECH BOLT ASSEMBLY

- d.6 Extract the cocking handle from the breech (ill. 18).
- d.7 Slide the breech bolt group forward and remove it from the receiver (ill. 19).

TRIGGER PLATE

- d.8 Depress the carrier stop push button.
- d.9 Ease out the trigger plate locking pin by pushing it from the left side of the shotgun using the point of a pin or a drift (ill. 20).
- d.10 Extract the trigger plate by levering on the trigger guard with a forward and downward movement (ill. 21).
- d.11 For any major cleaning of the trigger plate assembly disengage the safety and uncock the hammer, holding it with the left hand thumb. Ease the hammer forward.

Further disassembly of the shotgun is not recommended. This should be carried out by a gunsmith.

e. Cleaning and lubricating

Cleaning and lubrication of the shotgun after use is the best guarantee for protection of the parts against corrosion deriving from use of the firearm in humid and saline environment. It is advisable to avoid excessive, and unnecessary, frequency of disassembly and reassembly which might damage the firearm more than usage itself.

When combustion residues, grease or dirt particles have accumulated in the action, however, it is recommended to disassemble, clean and lubricate the shotgun.

BARREL

- After use clean accurately the barrel bore by pulling a swab through it to remove combustion residues. If necessary, use the cleaning rod with bronze brush and/or a rag soaked in Beretta detergent or other similar detergent. Clean accurately also the barrel tang locking shoulders.
- Pull a clean soft cloth through the barrel bore.
- Lightly lubricate the barrel bore by pulling through it a soft clean cloth dipped in Beretta lubricating oil or other similar oil.

c. Functioning and operation

When firing, the kinetic energy of the recoil advances, with regard to the receiver, the breech bolt assembly which compresses the spring positioned between the breech bolt and the bolt head; when the spring extends the bolt head is rotated by a cam, it clears the barrel and retracts, dragging, by means of the extractor, the empty shell casing which will be ejected through the ejection port. The next round, freed from the magazine tube at the moment of firing, is now positioned on the carrier. After having reached the point of maximum retraction through the pressure of the extending recoil spring, the breech bolt travels forward causing the carrier to lift the next round into "Feed" position. The bolt head, operated by the advancing breech bolt, pushes the round in the barrel and rotates, locking the barrel to the bolt. After the last round is fired, the breech bolt remains automatically in "Open" position.

Loading

ROUND IN BARREL AND ROUNDS IN MAGAZINE TUBE

- c.1 Engage the safety (see also point **b.4**).
- c.2 Retract the breech bolt by means of the cocking handle until it hooks into "Open" position.
Please note: Should the breech bolt not be retained in the open position because the hammer is cocked, with the breech bolt in "Closed" position depress the carrier stop push button and repeat point **c.2** (see also points **b.5** and **b.6**).
- c.3 Insert through the ejection port the first round in the cartridge chamber (ill. 12).
- c.4 Depress the breech bolt release button (see also point **b.10**) to lock the breech bolt.
- c.5 Insert through the loading gate the other rounds by placing each round on the carrier and pressing it down and forward in the magazine tube, until it engages the stop tooth (ill. 13).

Warning: THE FIREARM IS NOW LOADED AND READY TO BE FIRED. To fire disengage safety.

ROUNDS IN MAGAZINE TUBE ONLY

- c.6 Carry out the operations described at points **c.1**, **c.2**, **c.4**, **c.5**.

TRANSFER OF A ROUND FROM MAGAZINE TUBE TO CHAMBER

- c.7 Depress the carrier stop push button to extract a round from the magazine tube and position it on the carrier (see also point **b.5**). Take care where the shotgun points, even when it is on safety.
- c.8 Retract the breech bolt to its limit of travel and let it snap to "Close" position so it can chamber the round and complete the rotation of the bolt head in the barrel.

Warning: THE FIREARM IS NOW LOADED AND READY TO BE FIRED. To fire disengage safety.

To replace the round in the magazine tube repeat the operation of point **c.5**, with safety engaged.

Unloading

UNLOADING ROUND FROM CHAMBER

Please note: The Beretta 1200 F is a semi-automatic shotgun. Unless malfunctioning, when the shotgun is loaded the hammer is always in "Cocked" position, and the carrier in the top or magazine blocking position. The shotgun is designed to automatically repeat, at the moment of firing, the semi-automatism cycle. The breech bolt "Retained open" device is disconnected, the feed is blocked.

- c.9** Check that the safety is on.
- c.10** Retract the breech bolt with force enough to extract the live shotshell from the chamber. Take care where the shotgun points, even when it is on safety (**ill. 14**).
Remember that the breech bolt does not lock in the "Open," position.
- c.11** Snap-release the breech bolt to obtain complete rotation of the bolt head.
Please note: Extraction of the live shotshell from the chamber can be very useful in the field, both to guarantee maximum safety on difficult terrain and to chamber a shotshell of different composition for different usage.

COMPLETE UNLOADING OF SHOTGUN

- c.12** Carry out operations **c.9**, **c.10**, **c. 11** to extract the live cartridge from the chamber.
- c.13** Pressing down the carrier and at the same time using the breech bolt release button, ease exit of the shells from the magazine tube (**ill. 15**).
- c.14** Having checked that the magazine tube is empty, repeat the operation described at point **b.11**.

Warning: It is advisable to have the safety engaged when storing the shotgun.

d. Disassembly

BARREL

- d.1** Ensure that the shotgun is unloaded (chamber and magazine tube empty). If not, unload it by operating as described at points **c.9**, **c.10**, **c.11**, **c.13** and **c.14** in that sequence.
- d.2** If safety is not on, engage it.
- d.3** Unscrew, counterclockwise, and remove the fore-end cap. If the spring comes away from the cap, remove the spring. Remove the swivel (when mounted).

BREECH BOLT ASSEMBLY

- After use check the breech bolt assembly. If necessary, clean accurately the parts with brush and Beretta detergent or other similar detergent, with particular attention to the bolt head.
- Dry all parts with a soft lint free cloth and lightly lubricate with Beretta oil or other similar oil.

TRIGGER PLATE

- Operate as described for the breech bolt assembly.

RECEIVER (inside)

- If necessary, after use clean the internal parts of the receiver with a soft cloth, operating through the ejection port and the loading gate.
- With Beretta oil or other similar oil lightly lubricate the slide guide of the breech bolt inside the receiver.

f. Magazine capacity

The magazine tube capacity of the 1200 F (which in the sporting version has a 4/rd. capacity) has been limited to two rounds by the application of adaptors, in order to comply with the sporting gun laws in force in Italy and in other countries. These adaptors reduce the fire capacity of the 1200 F to no more than three rounds (two in the tube, one in the chamber).

The adaptors are incorporated in the shotgun during manufacturing and assembling operations.

In some areas shooting is allowed only with shotguns having a fire capacity of no more than two rounds. To use the 1200 F in these areas, therefore, it will be necessary to limit the tube capacity to only one round.

This operation must be carried out by a gunsmith.

To reduce the tube capacity to one round:

- f.1 Unscrew (anticlockwise) the magazine tube cap taking care to depress the cap locking spring with a peg or a drift at the beginning of the unscrewing operation (ill. 23).

Warning: The magazine tube spring, when mounted, is in a compressed condition (the yellow adaptors are held in place by the spring).

- f.2 Insert a third adaptor on the first two (the solid side into the hollow side) (ill. 24).
- f.3 Screw on (clockwise) the magazine tube cap on the tube until the spring head is in place in its hole, so as to lock the cap.

To increase the magazine tube capacity from three to four rounds, in the countries in which this is allowed, simply remove the adaptors.

g. Reassembly

TRIGGER PLATE

- g.1** Operate in the reverse order to what is described at point **d.12**, making sure that the hammer is cocked, the safety engaged, the carrier stop push button depressed.
- g.2** Insert, from the right side, the trigger plate retaining pin, ensuring that the trigger plate hole is centered on the receiver hole.

BREECH BOLT

- g.3** Depress (if it is not already depressed) the carrier stop push button.
- g.4** Rest the receiver on a flat surface, the ejection port uppermost. Insert the breech bolt inside the receiver until the connecting rod rests in the recoil spring guide housing.
- g.5** Place the cocking handle in its housing on the breech bolt and push until you hear the locking click.
- g.6** Bring the breech bolt in the open position.
Please note: If the breech bolt is crawled, slightly move it forward so as to have a repositioning of the connecting rod in the recoil spring guide housing, and repeat the breech bolt opening operation.

BARREL

- g.7** Operate, in sequence, as described at points **b.7**, **b.8**, **b.9**, **b.10** and **b.11**.
Note: When storing the shotgun it is always advisable to engage the safety.